

Schema per applicazione a singola cavità

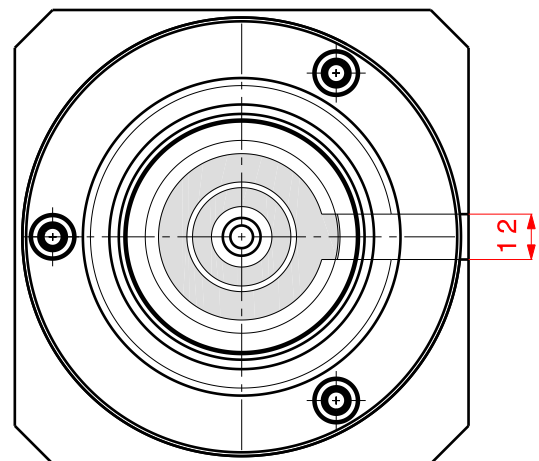
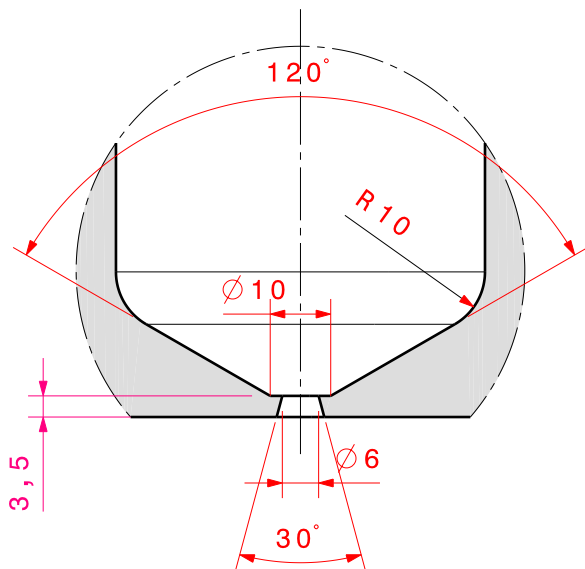
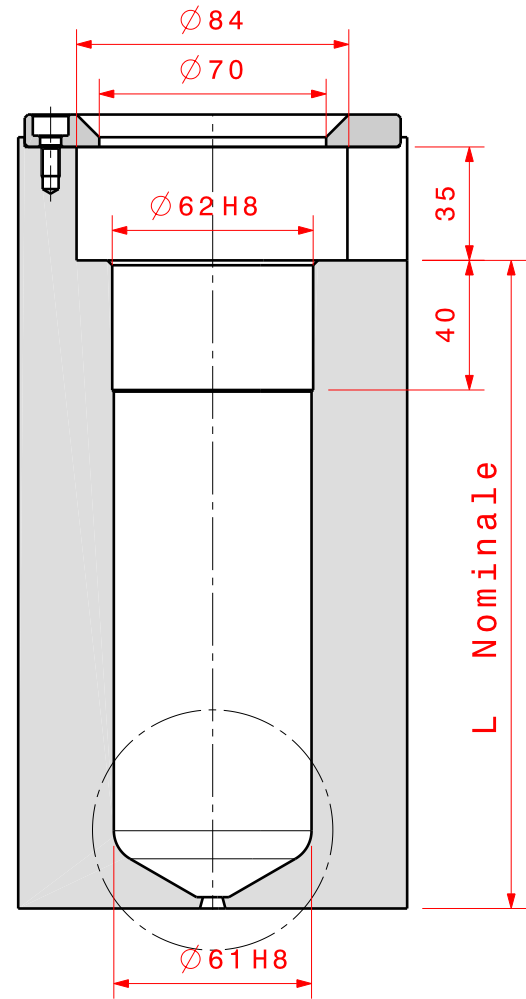
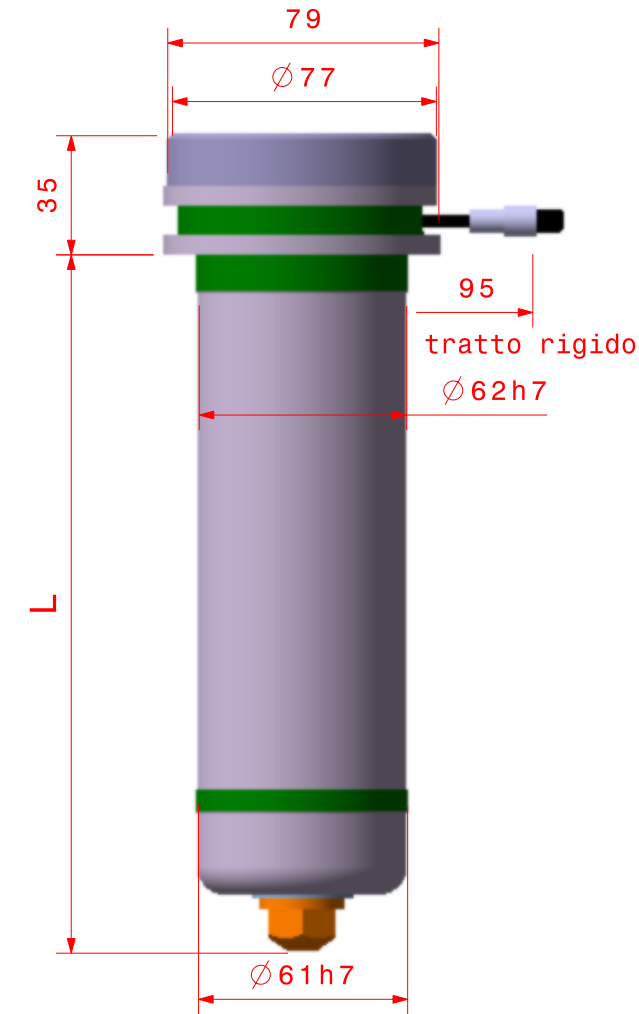

Codice Iniettore	L	Codice Stelo	Codice Bussola	Codice Puntale	Codice Resistenza	Codice Termocoppia	Peso massimo iniettabile
I 44200	200	S 40200	B 40200	P 44010	C 30020	C 15250	Grammi
I 44300	300	S 40300	B 40300	P 44010	C 30022	C 15350	12000
I 44400	400	S 40400	B 40400	P 44010	C 30024	C 15450	
I 44500	500	S 40500	B 40500	P 44010	C 30026	C 15550	
I 44600	600	S 40600	B 40600	P 44010	C 30028	C 15650	
I 44700	700	S 40700	B 40700	P 44010	C 30032	C 15750	
I 44800	800	S 40800	B 40800	P 44010	C 30034	C 15850	