

Schema per applicazione a singola cavità

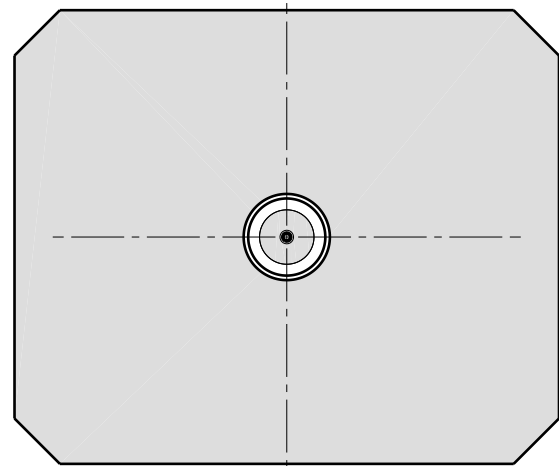
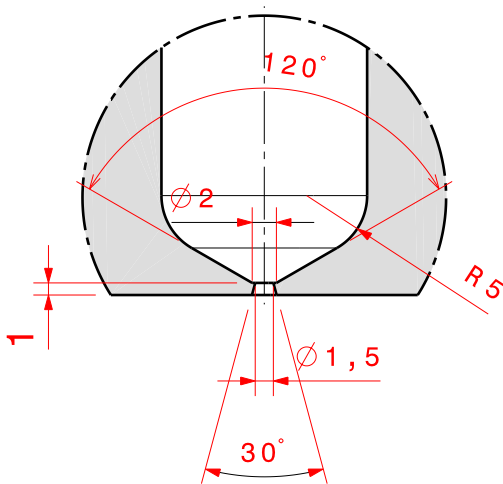
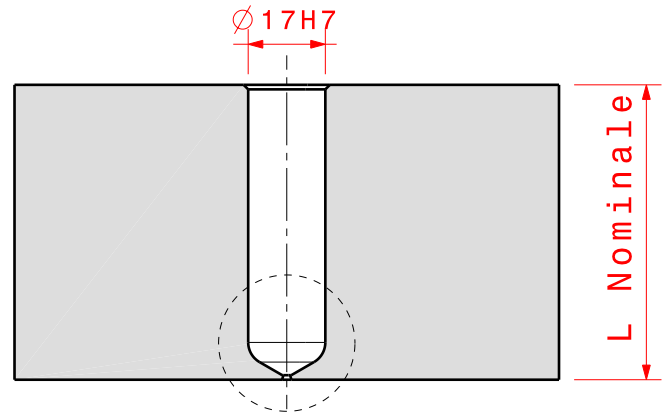
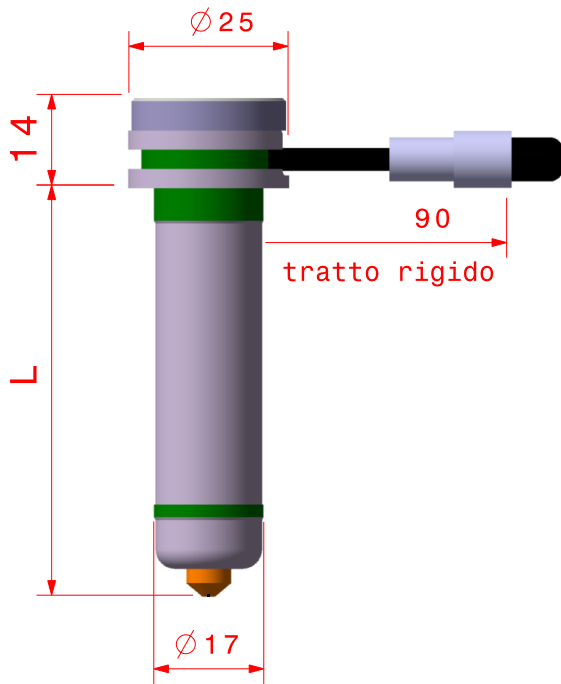

Codice Iniettore	L	Codice Stelo	Codice Bussola	Codice Resistenza	Codice Termocoppia	Peso massimo iniettabile
I 02035	35	S 02035	B 01035	C 08035	C 01810	Viscosità Grammi
I 02045	45	S 02045	B 01045	C 08045	C 01810	Bassa 100
I 02055	55	S 02055	B 01055	C 08055	C 01810	Media 60
I 02065	65	S 02065	B 01065	C 08065	C 01810	Alta 40