

Schema per applicazione
a singola cavità

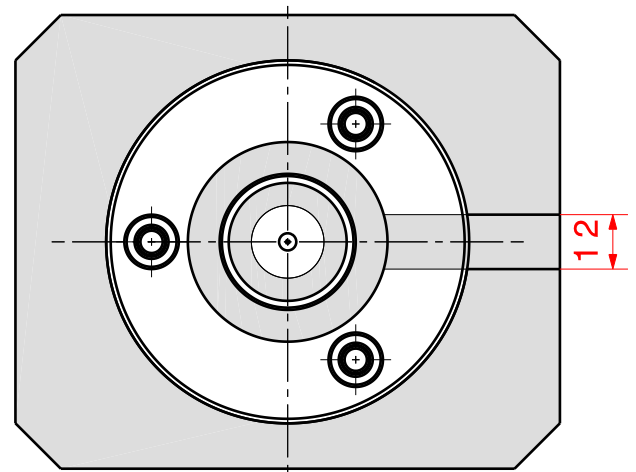
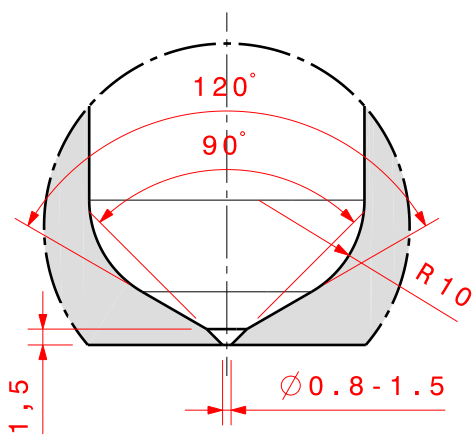
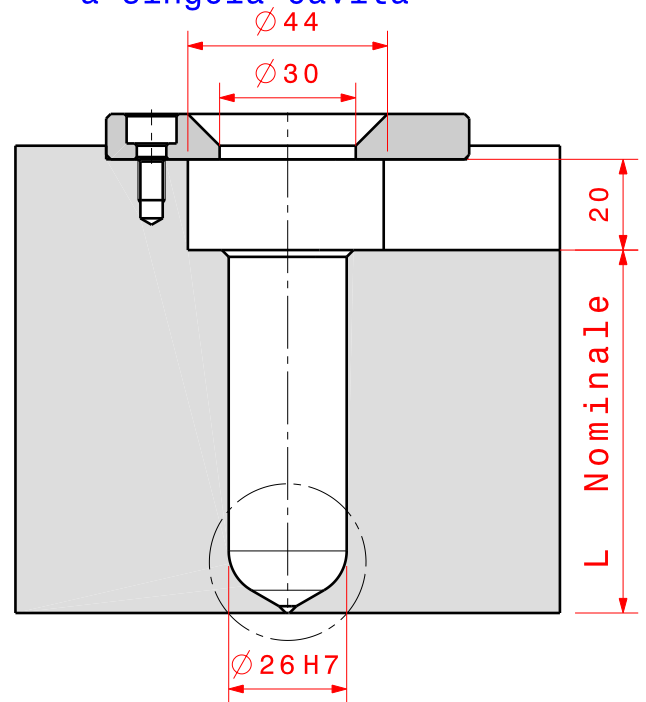
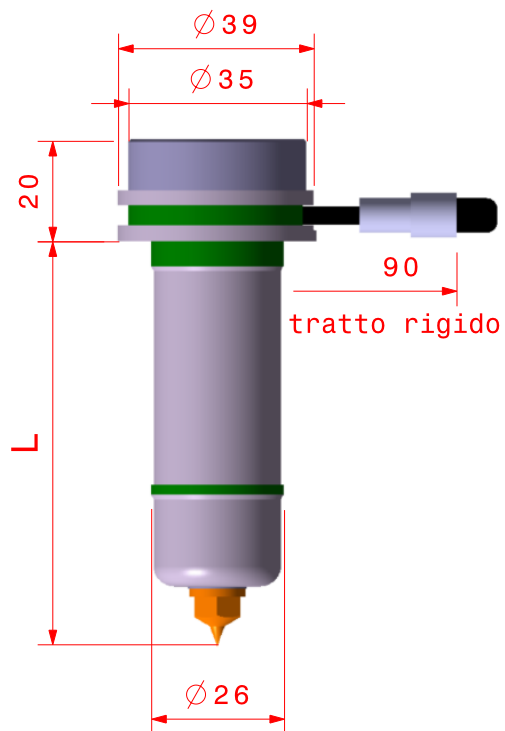

Codice Iniettore	L	Codice Stelo	Codice Bussola	Codice Puntale	Codice Resistenza	Peso massimo iniettabile	
I 10035	35	S 10035	B 10035	P 10010	C 12020	Viscosità	Grammi
I 10045	45	S 10045	B 10045	P 10010	C 12030	Bassa	120
I 10055	55	S 10055	B 10055	P 10010	C 12040	Media	70
I 10065	65	S 10065	B 10065	P 10010	C 12050	Alta	50
I 10080	80	S 10080	B 10080	P 10010	C 12060		
I 10100	100	S 10100	B 10100	P 10010	C 12070		